

SCHWERT – SYNONYM FÜR QUALITÄT & VERTRAUEN

Made in Germany

SWORD – SYNONYM FOR QUALITY & TRUST

Die erste Wahl

Instrumentarium für Neueinrichtung

The first choice

Instrument for new installation

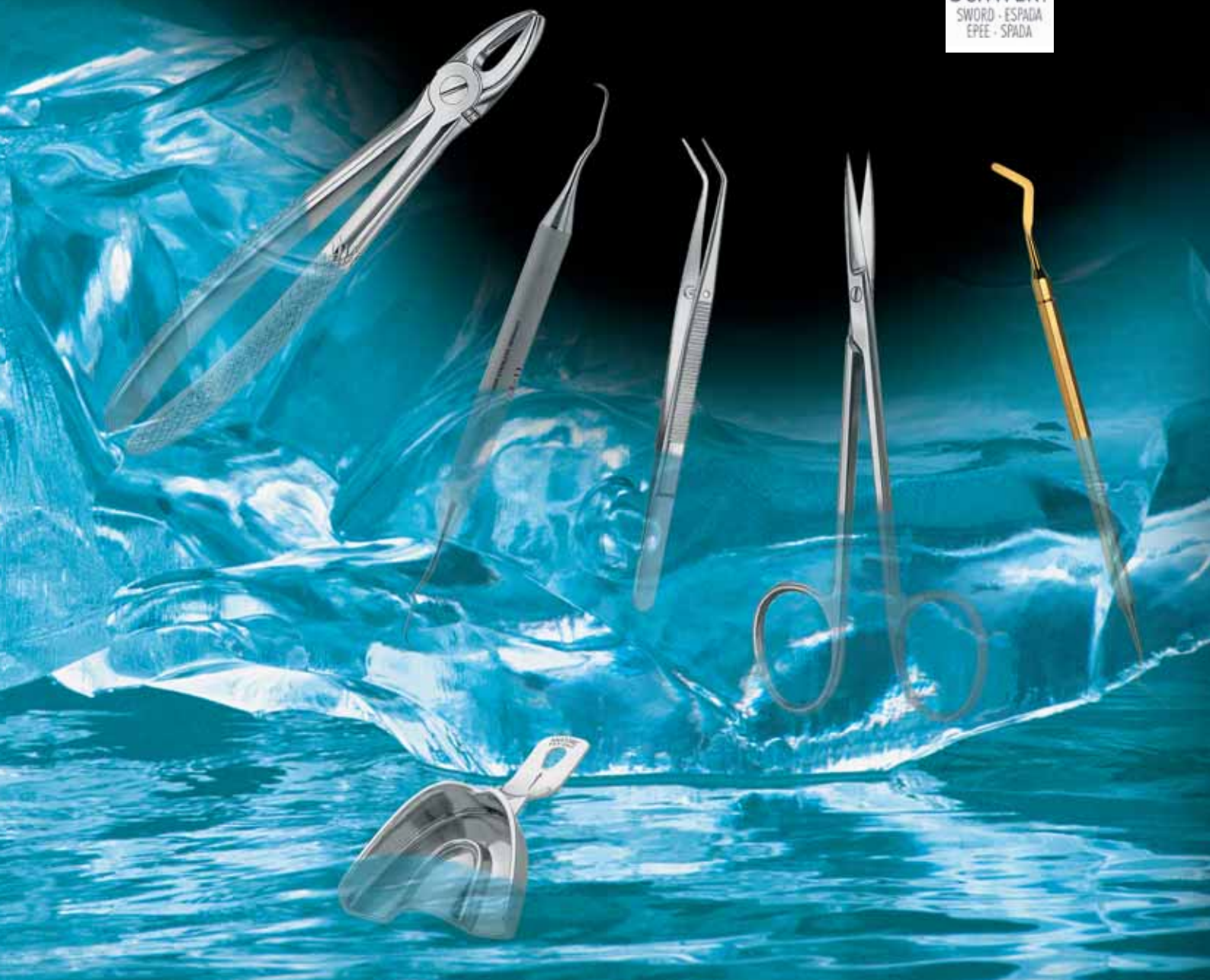

SCHWERT —

Synonym für Qualität und Vertrauen Synonym for Quality and Trust

INHALT

Mundspiegel u. -griffe, Zahnpinzetten	2.....	Mouth mirror and handles, Tweezers
Zahnsonden, Serviettenhalter	3.....	Explorers, Napkin holder
Exkavatoren, Zementspatel	4.....	Excavators, Cement spatulas
Flexible Spatel, Modellierinstrumente	5.....	Flexible spatulas, Carving instruments
Polierer, Dycalstopfer, Zahnreiner	6.....	Burnisher, Filling instruments, Scaler
Schleifstein, Teststäbchen, Schleiföl, (Matrizen-)Spanner	7.....	Sharpening stone, Tool for sharpening test, Oil, (Matrix-)Retainers
Parodontalsonden, Universalküretten	8.....	Periodontal probes, Universal curettes
Küretten, Zahnreiner, Steri-Rahmen	9.....	Curettes, Scaler, Instrument trays
Küretten, Farbringe, Steri-Rahmen	10-11	Curettes, Colour rings, Instrument trays
Zahnzangen	12-13	Dental forceps
Drehmeißel, Wurzelheber	14-15	Chisels, Elevators
Skalpellschneidmesser u. -griff, Zahnfleischscheren	16.....	Scalpel blades and handle, Gum scissors
Abhalter, Nadelhalter	17.....	Retractors, Needle holders
Raspatorien, Pinzetten	18.....	Raspatories, Forceps
Scharfe Löffel, Tamponstopfer, Hohlmeißelzange	19.....	Bone curettes, Tampon applicators, Rongeur forceps
Artikulationspapierpinzette, Retraktionsfadenstopfer,	20.....	Forceps for articulating paper, Gingival cord packer,
Teleskopkronenzange		Pliers for telescope crowns
Anmischspatel	21.....	Spatulas
Kronenabnehmerzangen, Hammer	22.....	Crown trial forceps, Mallet
Kronenabnehmer	23.....	Crown removers
Kronenschere, Gipsschneidezange, Zehntelmaß,	24.....	Crown scissors, Plaster cutting pliers, Decimal caliper,
Ligatur-, Drahtbiege-, Flach-, Kramponzange		Ligature -, Wire bending -, Flat nose -, Pin bending pliers
Modellierinstrumente, Wachsmesser	25.....	Carving instruments, Wax knives
Abformlöffel	26-27	Impression trays

CONTENT

SCHWERT- SYMBOL FÜR SPITZENQUALITÄT

SCHWERT-Produkte sind das Ergebnis einer über 100-jährigen Erfahrung in Herstellung und Vertrieb hochwertiger Instrumente. Unser Erfolg basiert auf unserer Philosophie, mit dem Anbieten höchster Qualität unseren Kunden bestmöglich zu dienen. Optimierung der Arbeitsergebnisse, Zeitersparnis durch einen rationalen Arbeitsprozess und Kostenersparnis durch eine lange Lebensdauer zeichnen unsere Produkte aus. SCHWERT-Produkte gelten als Tipp unter Kennern.

SWORD- SYMBOL FOR TOP-QUALITY

SWORD products are the result of more than 100 years experience in manufacturing and distributing instruments of superior quality. Our success is based on our philosophy that offering high quality instruments of German origin is the best we can do for the doctor, because they will allow a more precise and ergonomic work process and due to their long life time, they will be the cheapest instruments in the long run. SWORD products are highly appreciated by professionals.

IM ZEICHEN DES SCHWERTES

Korrosionsbeständigkeit, Härte, Abriebfestigkeit, Bruchsicherheit, mechanische und thermische Beanspruchung und Bearbeitbarkeit sind Materialeigenschaften, die sich zum Teil gegenseitig ausschließen. SCHWERT trifft für Sie die optimale Materialauswahl unter Berücksichtigung aller technischen und wirtschaftlichen Gesichtspunkte.

UNDER THE SIGN OF SWORD

Corrosion resistance, hardness, abrasion resistance, safety against fracture, mechanical load, thermal stress, workability and machinability, all these are material properties excluding themselves partly. In respect to these technical as well as to economical aspects, SWORD TAKES YOUR BEST CHOICE.

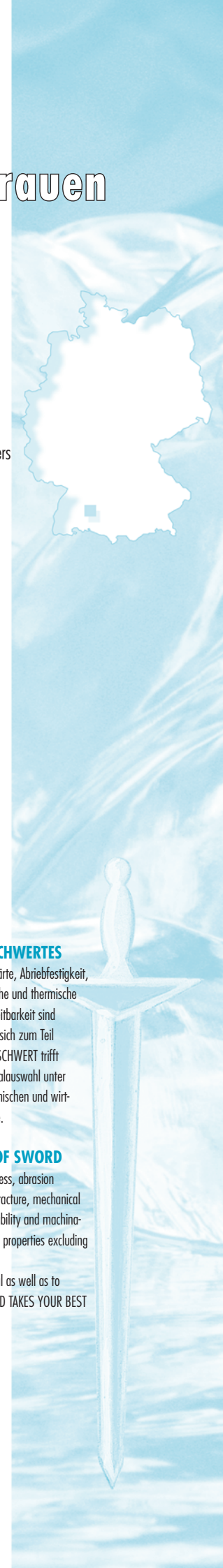

EIN VORSCHLAG FÜR DIE NEUEINRICHTUNG
A RECOMMENDATION FOR THE NEW INSTALLATION



MUNDSPIEGEL & GRIFFE
MOUTH MIRROR & HANDLES



2800-4 Ø 22 mm

plan
 plane



2784

hohl
 hollow



2787

hohl
 hollow

ZAHNPINZETTEN
TWEEZERS



2885 COLLEGE

gerieft
 serrated



2943 MERIAM

gerieft
 serrated

INSTRUMENTE FÜR DIE DIAGNOSTIK INSTRUMENTS FOR THE DIAGNOSIS



ZAHNSONDEN EXPLORERS

SERVIETTENHALTER NAPKIN HOLDER



2770



3007-6 UNIVERSAL

kräftige Spitzen
strong tips

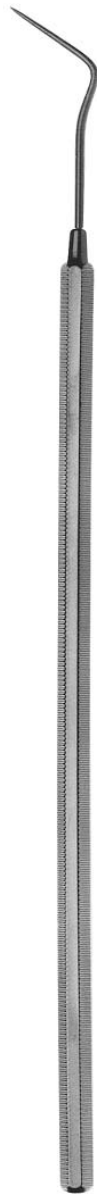

3007-9 UNIVERSAL

kräftige Spitzen
strong tips

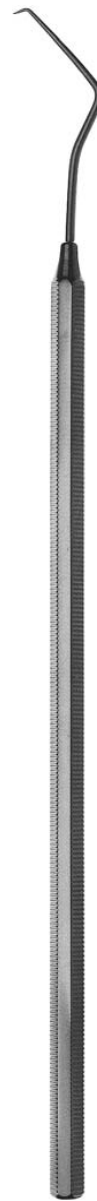

3007-17 UNIVERSAL

kräftige Spitzen
strong tips

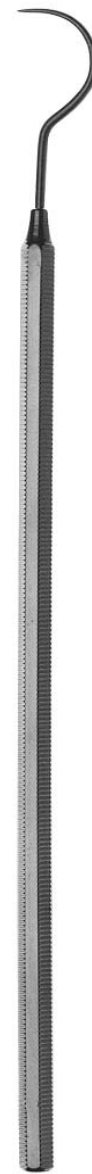

3007-23 UNIVERSAL

kräftige Spitzen
strong tips



EIN VORSCHLAG FÜR DIE NEUEINRICHTUNG A RECOMMENDATION FOR THE NEW INSTALLATION

EXKAVATOREN EXCAVATORS

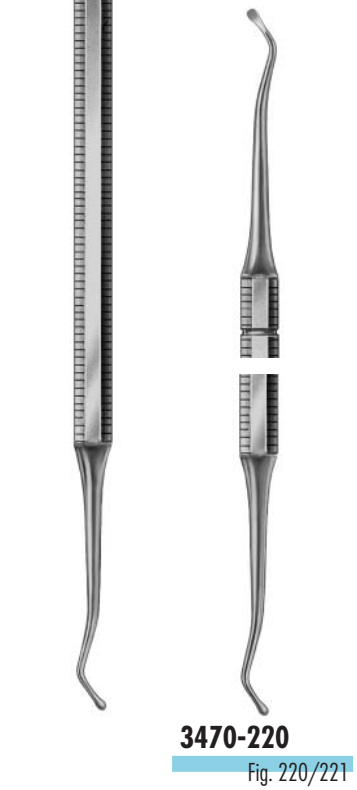
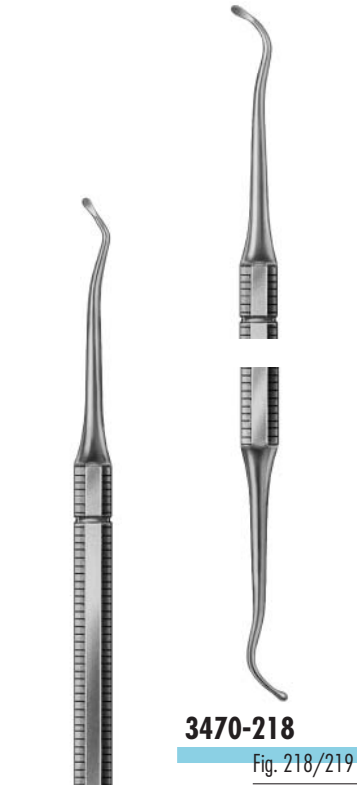
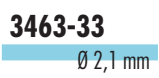
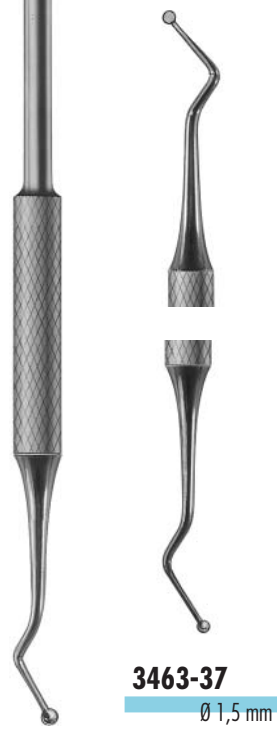

ZEMENTSPATEL CEMENT SPATULAS

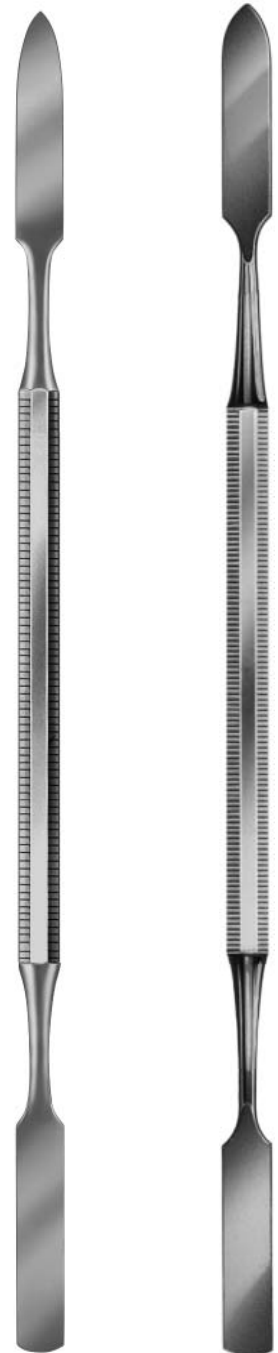

INSTRUMENTE FÜR DIE KONSERVIERENDE BEHANDLUNG INSTRUMENTS FOR THE CONSERVATIVE DENTISTRY



FLEXIBLE SPATEL HEIDEMANN FLEXIBLE SPATULAS HEIDEMANN

MODELLIERINSTRUMENTE CARVING INSTRUMENTS

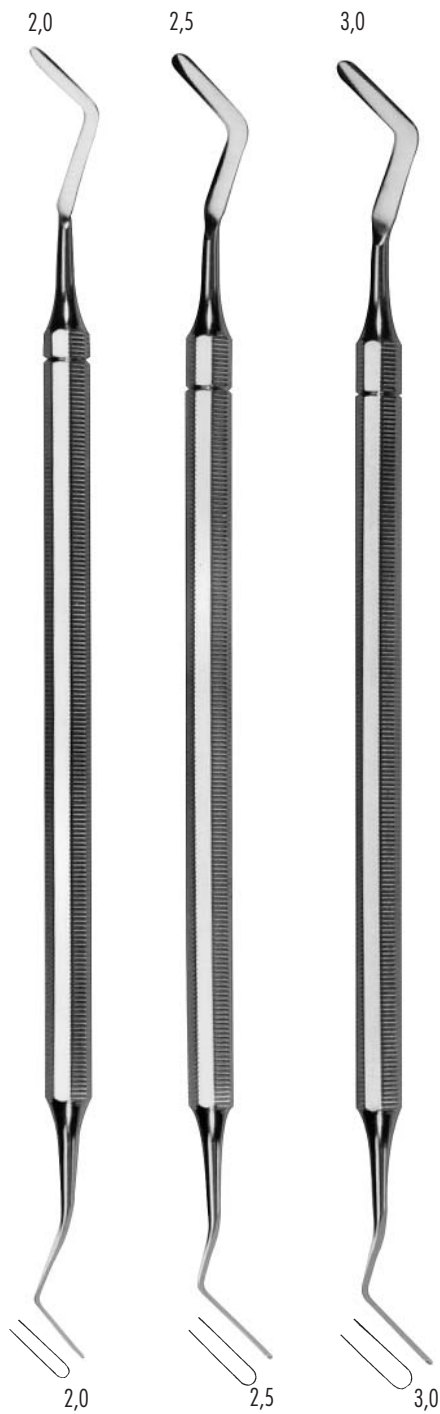

4088

4089

4090

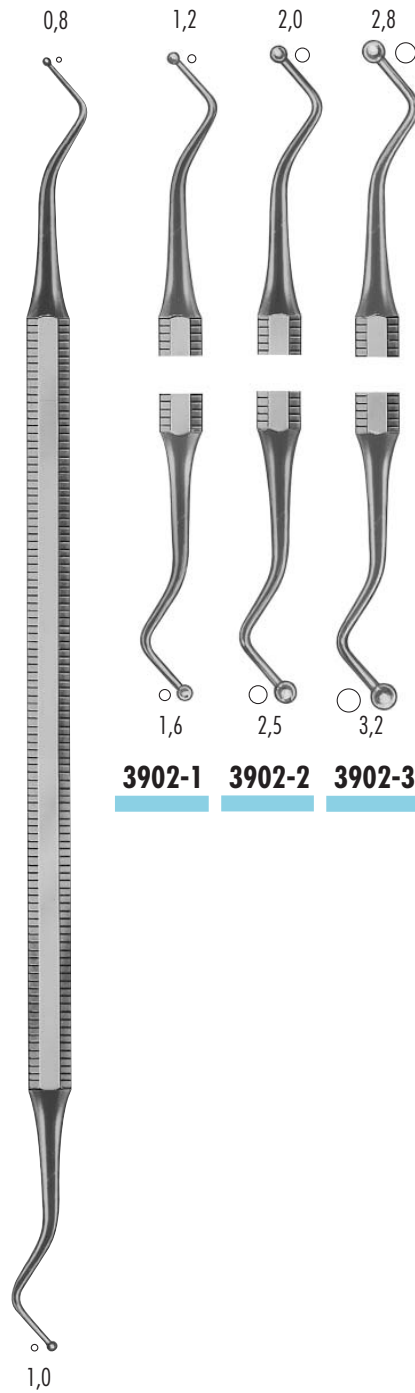

3902-1

3902-2

3902-3

3902-0

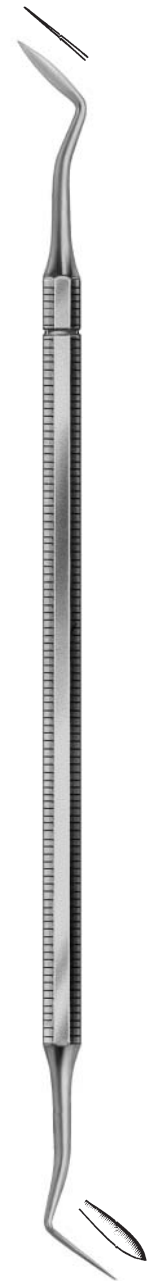

4430 HOLLENBACK



EIN VORSCHLAG FÜR DIE NEUEINRICHTUNG A RECOMMENDATION FOR THE NEW INSTALLATION

**POLIERER
BURNISHER**

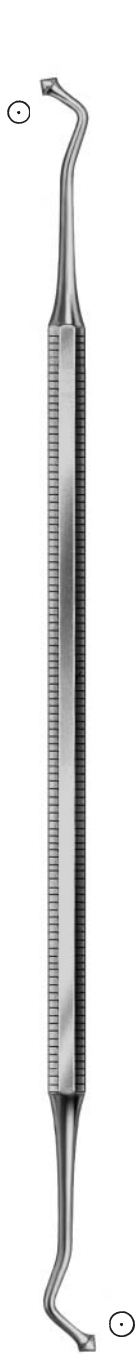

4122

**DYCALSTOPFER
FILLING INSTR. DYCAL**

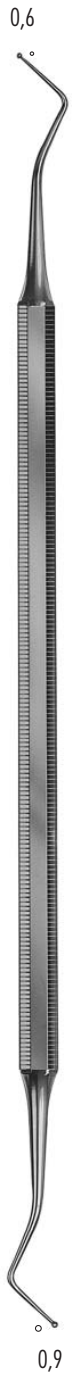

3904-50

**ZAHNREINIGER
SCALER**



3274-6

Fig. H 6/H 7



3274-204

Fig. 204 S

INSTRUMENTE FÜR DIE KONSERVIERENDE BEHANDLUNG INSTRUMENTS FOR THE CONSERVATIVE DENTISTRY

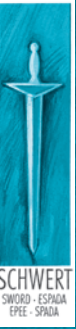

SCHLEIFSTEIN SHARPENING STONE

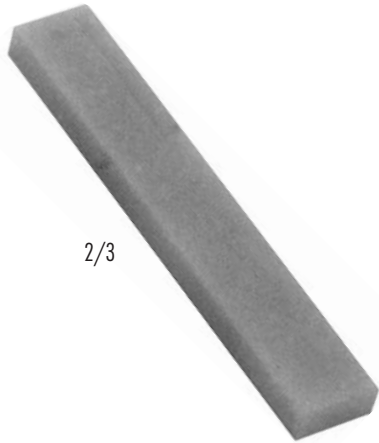

2/3

3289 ORIGINAL-ARKANSAS

sehr feinkörnig
very fine grain

ACRYL-TESTSTÄBCHEN TOOL FOR SHARPENING TEST

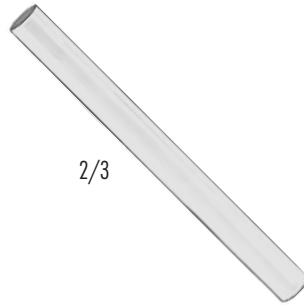

2/3

3292

Ø 7 mm

SCHLEIFÖL SHARPENING OIL



1/2

3297

MATRIZENSPANNER MATRIX RETAINERS



3585 FIG. 8

5 mm



3590 TOFFLEMIRE

Universal

MATRIZEN MATRIXES

3595 1 m x 5 mm

für/for 3585

3596 1 m x 6 mm

für/for 3587

3597 1 m x 7 mm

für/for 3587

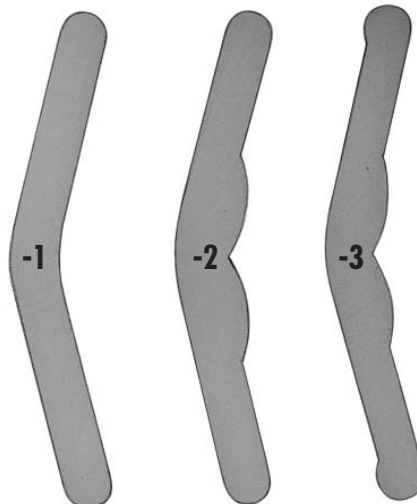

3592- (1-3) TOFFLEMIRE

3587 FIG. 8

7 mm



EIN VORSCHLAG FÜR DIE NEUEINRICHTUNG A RECOMMENDATION FOR THE NEW INSTALLATION

PARODONTALSONDEN PERIODONTAL PROBES

UNIVERSALKÜRETETTEN COLUMBIA UNIVERSAL CURETTES COLUMBIA



3410-1 WHO



3419-3-3

Fig. CP12



3419-3-6

Fig. CP11



3379-2

Fig. 2L/2R

☞ 1-5



3379-4

Fig. 4L/4R

☞ 6-8

INSTRUMENTE FÜR DIE KONSERVIERENDE BEHANDLUNG INSTRUMENTS FOR THE CONSERVATIVE DENTISTRY



**KÜRETTEN
CURETTES**

**STERI-RAHMEN
INSTRUMENT TRAYS**

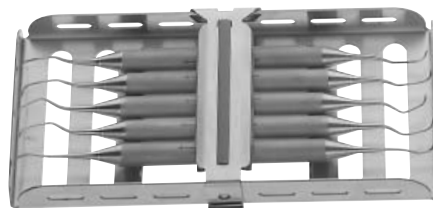

**ZAHNREINIGER
SCALER**

2598 PROTECTOR

für 5 Instrumente, 3 Rahmen pro Normtray
for 5 instruments, 3 racks per standard tray



3373-5 GRACEY

Fig. 5/6

☞ 1-5



3373-7 GRACEY

Fig. 7/8

☞ 4-8
lingual + buccal



3373-11 GRACEY

Fig. 11/12

☞ 4-8
mesial



3373-13 GRACEY

Fig. 13/14

☞ 4-8
distal

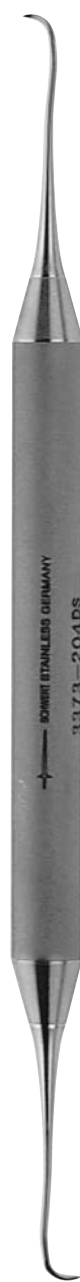

3373-204 DS

Fig. 204 DS

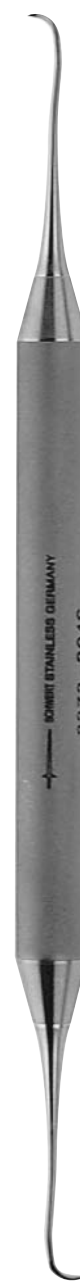

3373-204S

Fig. 204 S

EIN VORSCHLAG FÜR DIE NEUEINRICHTUNG A RECOMMENDATION FOR THE NEW INSTALLATION

KÜRETTEN CURETTES



GRACEY



3374-5 GRACEY

Fig. 5/6

☞ 1-5

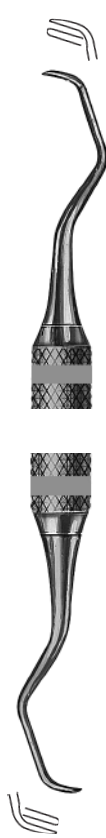

3374-7 GRACEY

Fig. 7/8

lingual + buccal

☞ 4-8



3374-11 GRACEY

Fig. 11/12

mesial

☞ 4-8



3374-13 GRACEY

Fig. 13/14

distal

☞ 4-8

FARBRINGE COLOUR RINGS



3360-1 GRAU/GREY

P. of 50 pcs.



3360-3 SCHWARZ/BLACK

P. of 50 pcs.



3360-5 GELB/YELLOW

P. of 50 pcs.



3360-7 GRÜN/GREEN

P. of 50 pcs.



3360-9 ROT/RED

P. of 50 pcs.



3360-11 ORANGE/ORANGE

P. of 50 pcs.



3360-13 BLAU/BLUE

P. of 50 pcs.



3360-15 BRAUN/BROWN

P. of 50 pcs.



3360-17 WEISS/WHITE

P. of 50 pcs.

INSTRUMENTE FÜR DIE KONSERVIERENDE BEHANDLUNG INSTRUMENTS FOR THE CONSERVATIVE DENTISTRY



KÜRETTEN (für tiefe Taschen, mit Farbringen erweiterbar) CURETTES (for deep pockets, extendable with colour rings)



GRACEY
miniatur



3377-105 GRACEY

Fig. 5/6, miniatur
☞ 1 - 5



3377-107 GRACEY

Fig. 7/8, miniatur
lingual + buccal
☞ 4 - 8



3377-111 GRACEY

Fig. 11/12, miniatur
mesial
☞ 4 - 8



3377-113 GRACEY

Fig. 13/14, miniatur
distal
☞ 4 - 8

STERI-RAHMEN INSTRUMENT TRAYS



2598-10 PROTECTOR

für 10 Instrumente, 2 Rahmen pro Normtray
for 10 instruments, 2 racks per standard tray



1700-510

für 22 Instrumente, 275 x 175 x 25 mm
for 22 instruments, 275 x 175 x 25 mm



EIN VORSCHLAG FÜR DIE NEUEINRICHTUNG A RECOMMENDATION FOR THE NEW INSTALLATION

ZAHNZANGEN - auch im 10er-Set erhältlich
DENTAL FORCEPS - also available at a set of 10 instruments



152-1

☞ 11-13; 21-23

für obere Schneide- u. Eckzähne, breit
for upper incisors and canines, wide

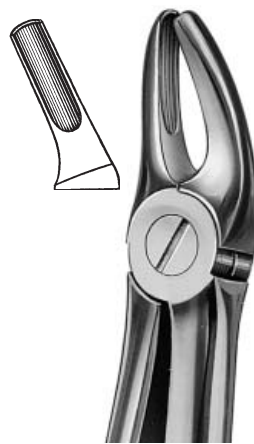

152-7

☞ 14-15, 24-25

für obere Prämolaren
for upper premolars

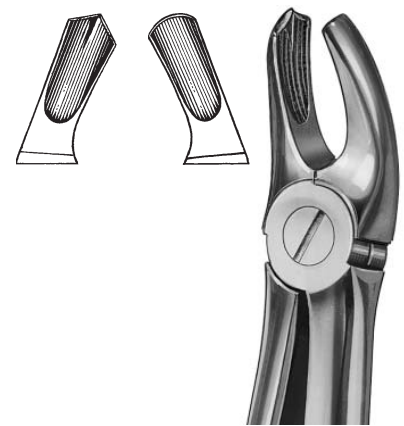

152-17

☞ 16-18

für obere Molaren, rechts
for upper molars, right



152-18

☞ 26-28

für obere Molaren, links
for upper molars, left

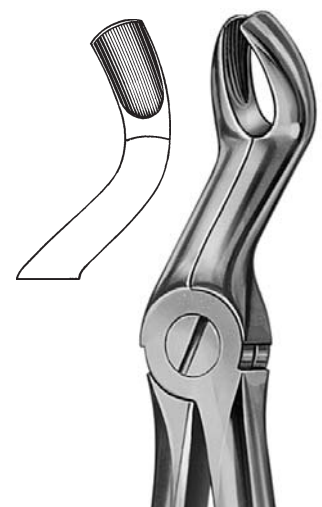

152-67A

☞ 18, 28

für obere Weisheitszähne, breit
for upper wisdom teeth, wide

INSTRUMENTE FÜR DIE EXTRAKTION INSTRUMENTS FOR THE EXTRACTION



ZAHNZANGEN - auch im 10er-Set erhältlich
DENTAL FORCEPS - also available at a set of 10 instruments



152-51
für obere Wurzeln, kurzes, schmales Maul
for upper roots, short and narrow beaks



152-13
☞ 34-35, 44-45
für untere Eckzähne und Premolaren
for lower canines and premolars



152-22
☞ 36-37, 46-47
für untere Molaren, beide Seiten
for lower molars, either side

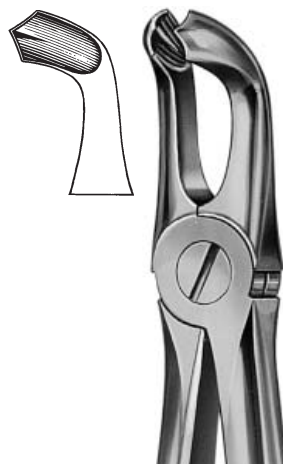

152-79
☞ 38, 48
für untere Weisheitszähne
for lower wisdom teeth



152-33
für untere Schneidezähne,
Prämolaren und Wurzeln
for lower incisors, premolars
and roots



EIN VORSCHLAG FÜR DIE NEUEINRICHTUNG A RECOMMENDATION FOR THE NEW INSTALLATION

DREHMEISSEL CHISELS

gerade / straight, 13 cm

925-2 2 mm

925-3 3 mm

925-4 4 mm

bajonett / bayonet, 13 cm

926-2 2 mm

926-3 3 mm

926-4 4 mm

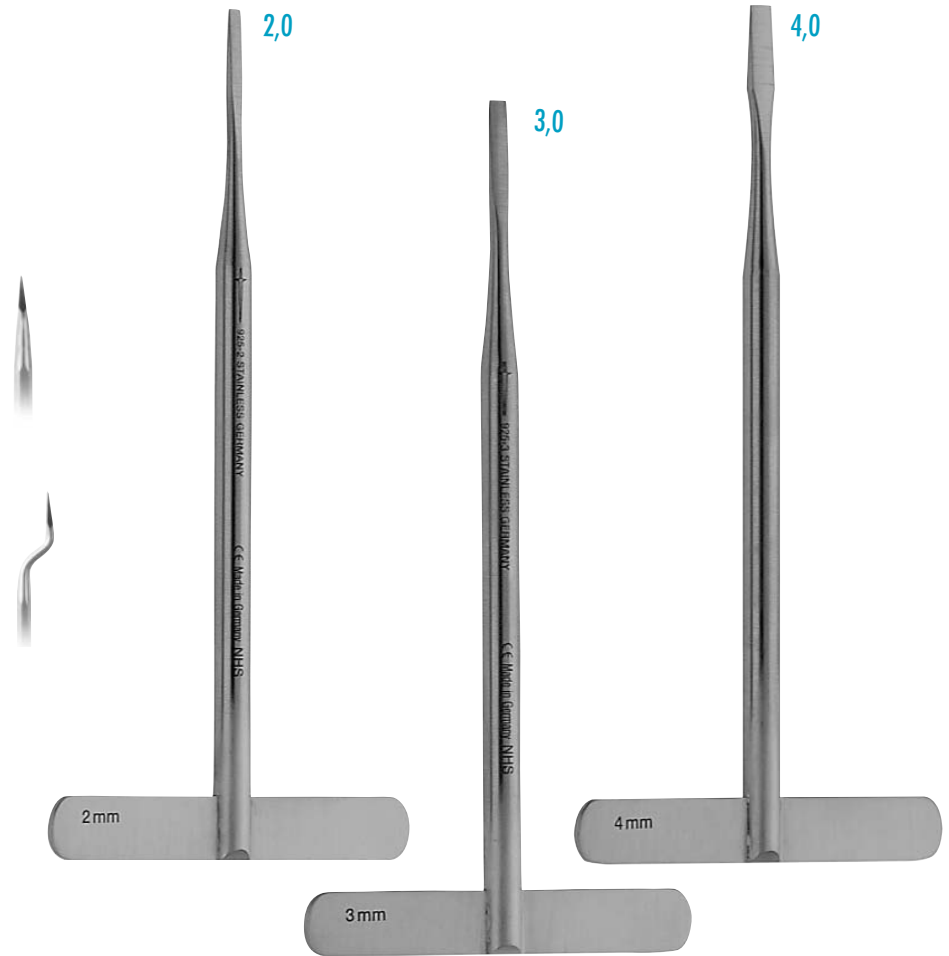

WURZELHEBER - gerade ELEVATORS - straight

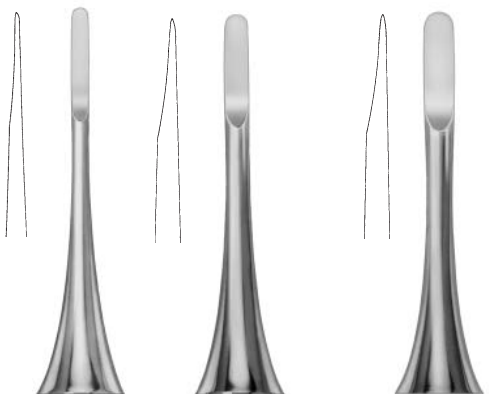

614-2 LUXATOR
2 mm

614-3 LUXATOR
3 mm

614-4 LUXATOR
4 mm

WURZELHEBER - gebogen ELEVATORS - curved

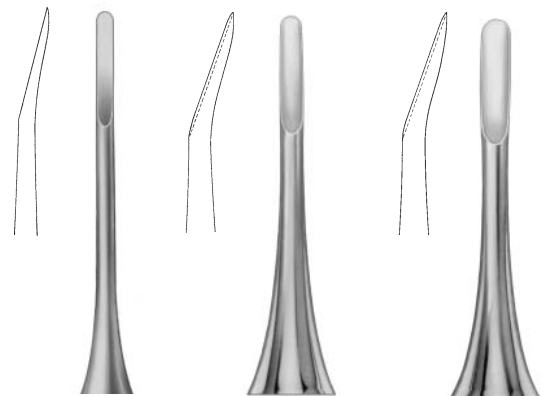

614-12 LUXATOR
2 mm

614-13 LUXATOR
3 mm

614-14 LUXATOR
4 mm

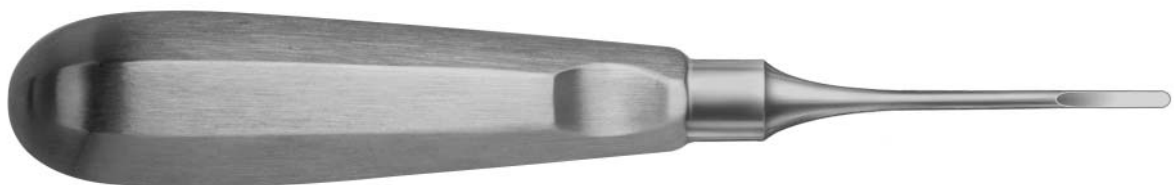



WURZELHEBER
ELEVATORS



620-2 BEIN
 2 mm



620-3 BEIN
 3 mm



620-4 BEIN
 4 mm



830-1 CRYER



830-2 CRYER



810



811



EIN VORSCHLAG FÜR DIE NEUEINRICHTUNG A RECOMMENDATION FOR THE NEW INSTALLATION

SKALPELLGRIFF SCALPEL HANDLE



2/3

1043 FIG. 3

SKALPELLKLINGEN SCALPEL BLADES



	unsteril non-sterile	steril sterile
Fig. 10	1053-10	1063-10
Fig. 11	1053-11	1063-11
Fig. 12d	1053-12D	1063-12D
Fig. 15	1053-15	1063-15

ZAHNFLEISCHSCHEREN GUM SCISSORS



2/3

1110 STANDARD

11,5 cm

1110-400 SUPER CUT

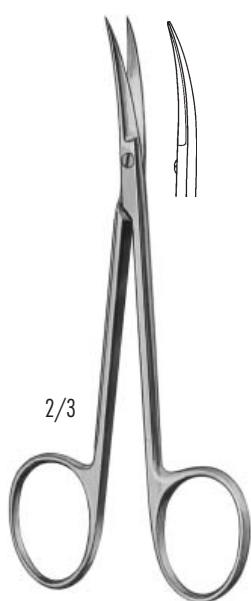

2/3

1111 STANDARD

11,5 cm

1111-400 SUPER CUT

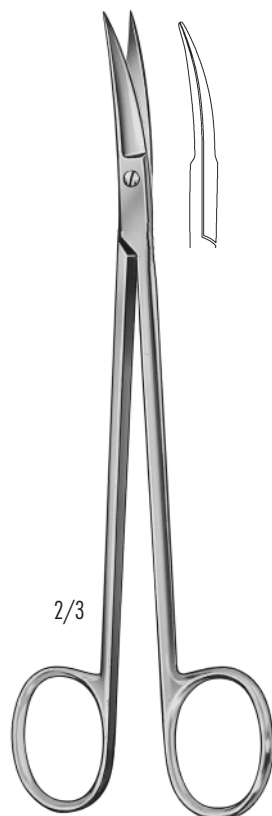

2/3

1143 KELLY

16 cm

1143-400 SUPER CUT

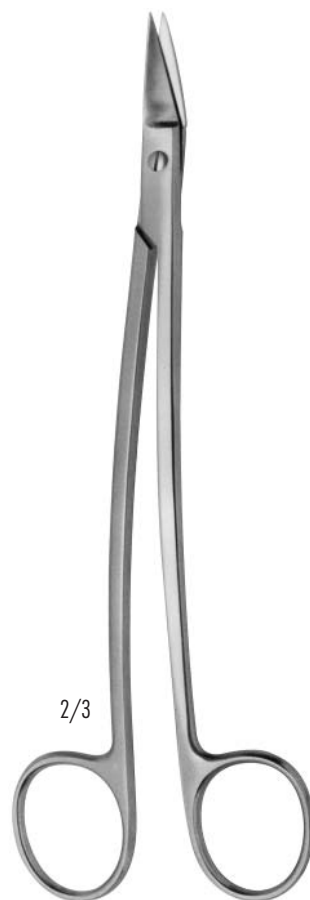

2/3

1147-1 DEAN

17,5 cm, gezahnt

17,5 cm, saw edge

**INSTRUMENTE FÜR DIE EXTRAKTION
INSTRUMENTS FOR THE EXTRACTION**



**ABHALTER
RETRACTORS**

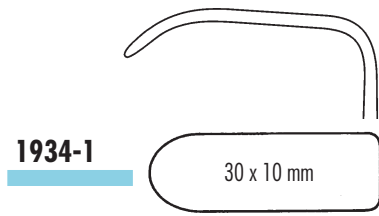

1934-1

30 x 10 mm

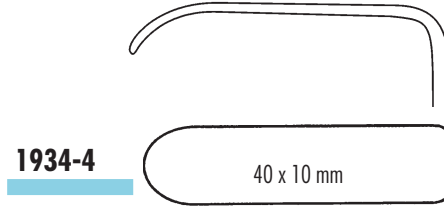

1934-4

40 x 10 mm



2/3

LANGENBECK

22 cm

**NADELHALTER
NEEDLE HOLDERS**

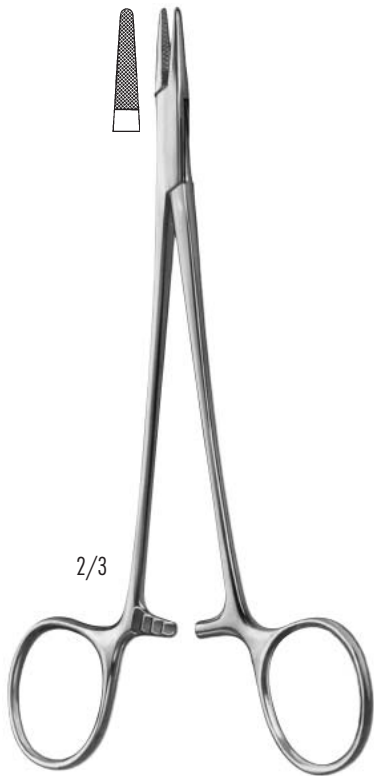

2/3

2014 CRILE-WOOD TC

15 cm, Hartmetalleinsätze

15 cm, Tungsten carbide inserts



2/3

2016-16 MAYO-HEGAR

16 cm

EIN VORSCHLAG FÜR DIE NEUEINRICHTUNG
A RECOMMENDATION FOR THE NEW INSTALLATION

RASPATORIEN
RASPATORIES

PINZETTEN SEMKEN
FORCEPS SEMKEN

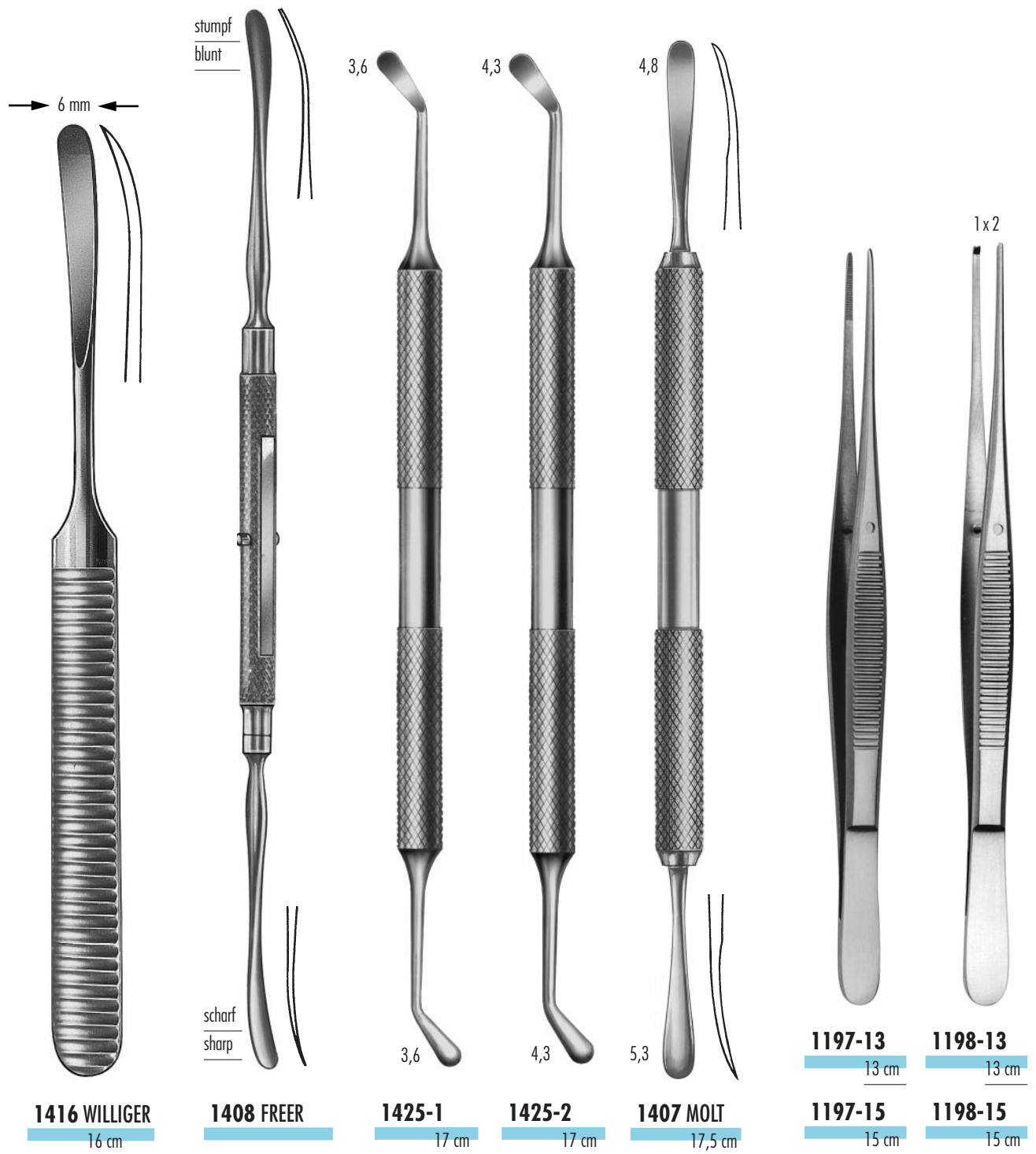

INSTRUMENTE FÜR DIE CHIRURGIE
INSTRUMENTS FOR THE SURGERY



SCHARFE LÖFFEL
BONE CURETTES

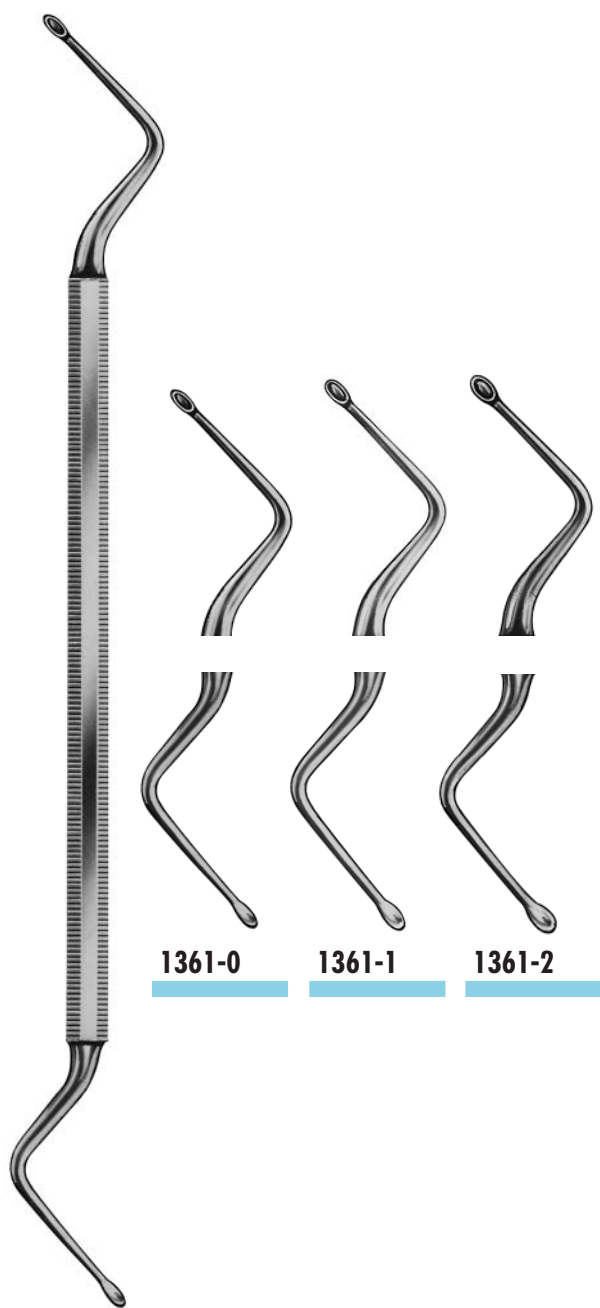

HEMINGWAY
 17 cm

1361-0

1361-1

1361-2

TAMPONSTOPFER
TAMPON APPLICATOR



1,8

1510-1 LUNIATSCHEK

HOHLMEISSELZANGE
RONGEUR FORCEPS



431 FRIEDMANN
 14 cm

EIN VORSCHLAG FÜR DIE NEUEINRICHTUNG
A RECOMMENDATION FOR THE NEW INSTALLATION

ARTIKULATIONS-PAPIERPINZETTE
FORCEPS FOR ARTICULATING PAPER



4890 MILLER

RETRAKTIONSFADENSTOPFER
GINGIVAL CORD PACKER



4880-3 UNIVERSAL

45°, gezahnt
 45°, saw edge



4880-4

45°, gezahnt
 45°, saw edge

TELESKOPKRONENZANGE
PLIERS FOR TELESCOPE CROWNS

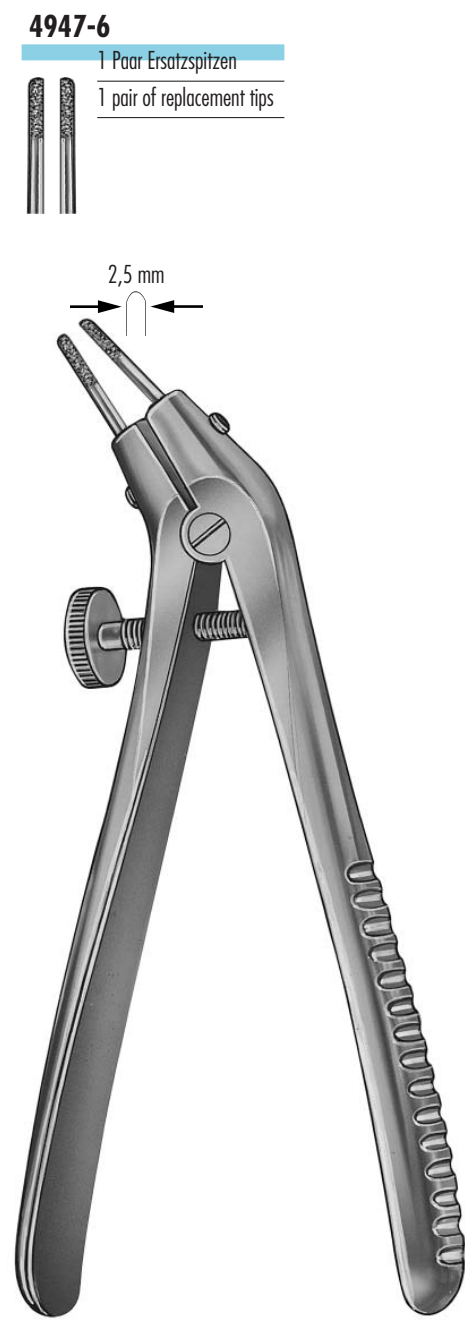

4947-5

13,5 cm, diamantierte Spitzen, auswechselbar
 13,5 cm, diamonded tips, replaceable

4947-6

1 Paar Ersatzspitzen
 1 pair of replacement tips



2,5 mm





ANMISCHSPATEL
SPATULAS



4560
19 cm, sehr flexibel
19 cm, very flexible



4570 LICHTENSTEIN
17 cm

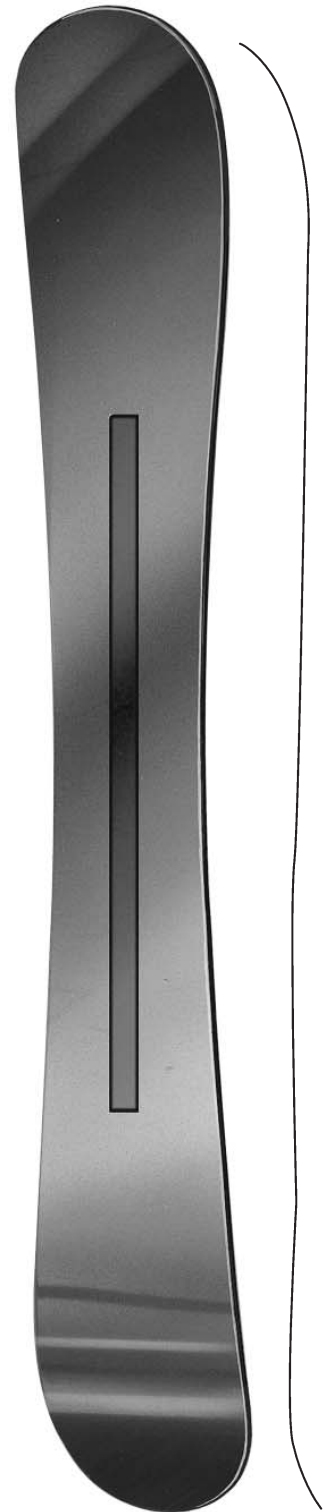

4571
20 cm

EIN VORSCHLAG FÜR DIE NEUEINRICHTUNG
A RECOMMENDATION FOR THE NEW INSTALLATION

KRONENABNEHMEZANGEN
CROWN TRIAL FORCEPS

HAMMER
MALLET



4940-100

1 Paar Kunststoffbacken

1 pair of inserts



4940-17

13 - 18, 23 - 28



4940-22

33 - 38, 43 - 48



1626

19 cm, 200 g, bleigefüllt

19 cm, 200 g, lead filled



KRONENABNEHMER
CROWN REMOVERS

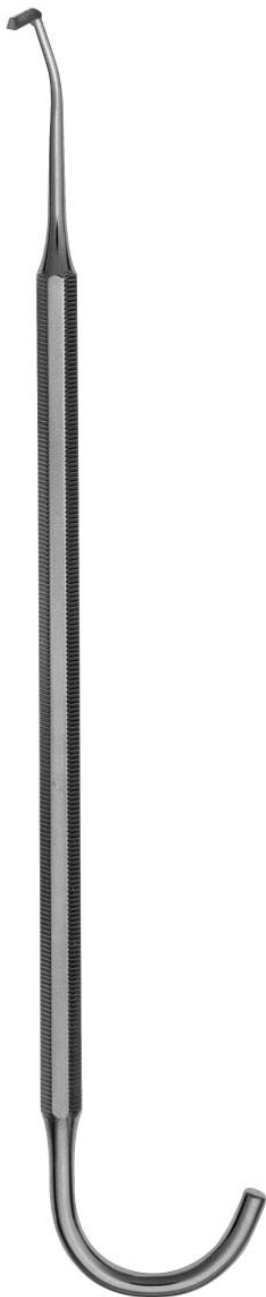

4920 TREYMANN



4927 UNIVERSAL

☞ 1-8



4925 MORELL

mit Ansätzen Nr. 4924-1 + 4924-2
with tips no. 4924-1 + 4924-2



4924-1



4924-2

EIN VORSCHLAG FÜR DIE NEUEINRICHTUNG
A RECOMMENDATION FOR THE NEW INSTALLATION

KRONENSCHERE
CROWN SCISSORS

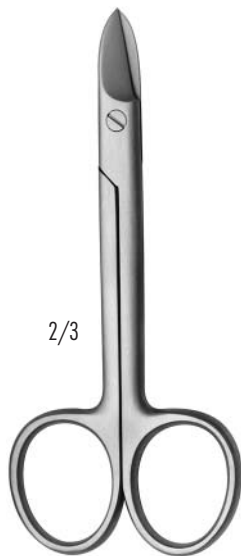

4825 BEEBEE
 spitz, gebogen
 sharp, curved

GIPSSCHNEIDEZANGE
PLASTER CUTTING PLIERS



4558
 20 cm

ZEHNTELMASS
DECIMAL CALIPER

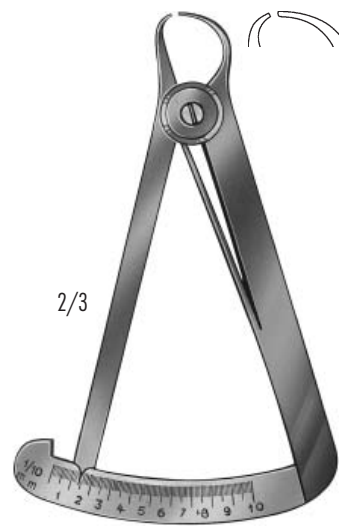

4894 IWANSON
 10 cm

LIGATURZANGE
LIGATURE PLIERS

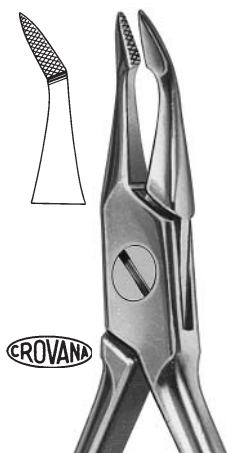

5309 WEINGART
 13 cm

DRAHTBIEGEZANGE
WIRE BENDING PLIERS

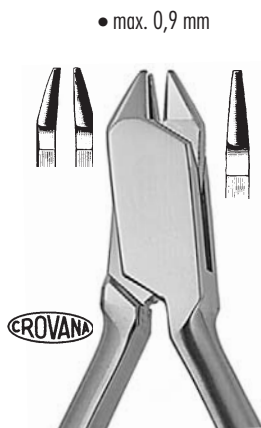

5133 ADERER
 13 cm, Fig. 200

FLACHZANGE
FLAT NOSE PLIERS



5024
 13 cm, gerieft
 13 cm, serrated

KRAMPONZANGE
PIN BENDING PLIERS

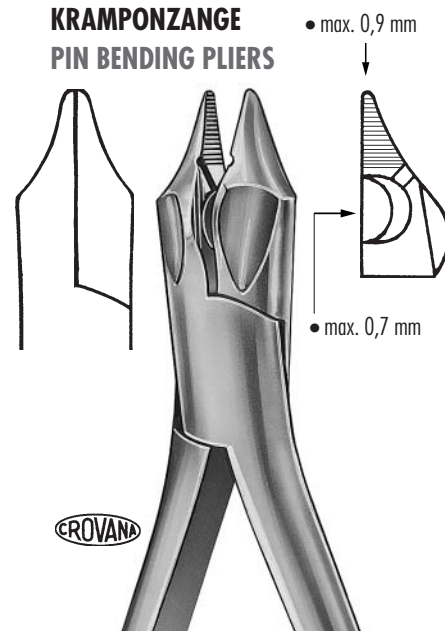

5600
 15 cm



INSTRUMENTE FÜR DIE PROTHETIK INSTRUMENTS FOR THE PROTHODONTIA



MODELLIERINSTRUMENTE CARVING INSTRUMENTS

WACHSMESSER WAX KNIVES



4444 LE CRON

4446 HYLIN-LE CRON



4510 FAHNENSTOCK

13 cm

4512 FAHNENSTOCK

17 cm

4542 GRITMANN

16 cm



EIN VORSCHLAG FÜR DIE NEUEINRICHTUNG A RECOMMENDATION FOR THE NEW INSTALLATION

ABFORMLÖFFEL ANATOMIC-PERIGRIP IMPRESSION TRAYS ANATOMIC-PERIGRIP

Oberkiefer
Upper jaw

Unterkiefer
Lower jaw



a
+ / - 1,5 mm

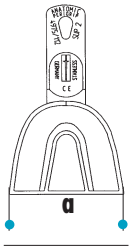

4975-111	64 mm	SUP 1
4975-112	66 mm	SUP 2
4975-113	70 mm	SUP 3
4975-114	72 mm	SUP 4
4975-115	79 mm	SUP 5



a
+ / - 1,5 mm

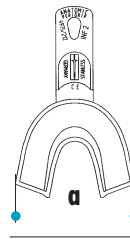

4975-211	70 mm	INF 1
4975-212	72 mm	INF 2
4975-213	75 mm	INF 3
4975-214	77 mm	INF 4
4975-215	79 mm	INF 5

ANATOMIC - für schmale Unterkiefer ANATOMIC - for narrow lower jaws

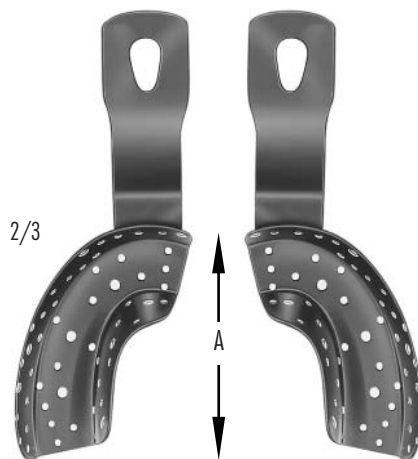

4978-1 FIG. L1

A = 46 mm

4979-1 FIG. R1

A = 46 mm

4978-2 FIG. L2

A = 50 mm

4979-2 FIG. R2

A = 50 mm

4978-3 FIG. L3

A = 55 mm

4979-3 FIG. R3

A = 55 mm



4983 STOLLEY

mit Schraube

with screw

ABFORMLÖFFEL ANATOMIC-EHRICKE
IMPRESSION TRAYS ANATOMIC-EHRICKE

Oberkiefer
Upper jaw



4972-110 SUP B0

4972-111 SUP B1

4972-112 SUP B2

4972-113 SUP B3

4972-114 SUP B4

Bezahnte Kiefer (BO)

Regulars

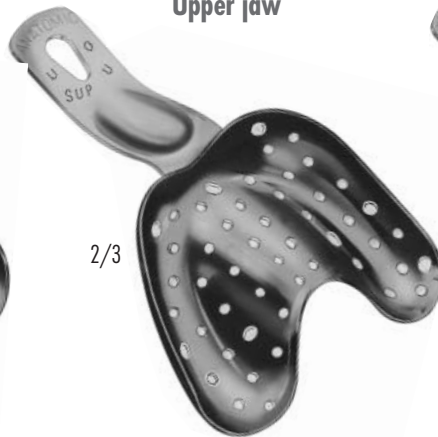

4972-131 SUP U1

4972-132 SUP U2

4972-133 SUP U3

Unbezahnte Kiefer (UO)

Edentulos

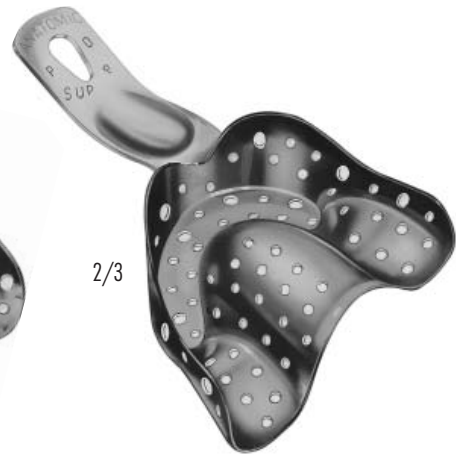

4972-121 SUP P1

4972-122 SUP P2

4972-123 SUP P3

Partiell bezahnte Kiefer (PO)

Partials, depressed centers

Unterkiefer
Lower jaw



4972-221 INF P1

4972-222 INF P2

4972-223 INF P3

Partiell bezahnte Kiefer (PU)

Partials, depressed centers



4972-210 INF B0

4972-211 INF B1

4972-212 INF B2

4972-213 INF B3

4972-214 INF B4

Bezahnte Kiefer (BU)

Regulars

EIN VORSCHLAG FÜR DIE NEUEINRICHTUNG A RECOMMENDATION FOR THE NEW INSTALLATION

Ihre persönliche Bedarfsliste:

Unser Neueinrichtungsvorschlag ist als erste Orientierung für Sie gedacht.

Sie können gerne die folgenden Listen ausschneiden und Ihren individuellen Bedarf zusammenstellen. Ihr Depot erstellt Ihnen dann ein persönliches Angebot!

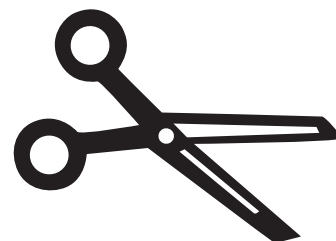

SCHWERT Art.-Nr. SWORD art.-no.	Text Text	Menge Quantity	Einzelpreis Unit price	Gesamtpreis Total price
Instrumente für die Diagnostik/Instruments for the diagnosis				
2770	Serviettenhalter Napkin holder			
2784	Mundspiegelgriff, hohl Mouth mirror handle, hollow			
2787	Mundspiegelgriff Mouth mirror handle, hollow			
2800-4	Mundspiegel, plan Mouth mirror, plane			
2885	Zahnpinzette COLLEGE, gerieft Tweezers COLLEGE, serrated			
2943	Zahnpinzette MERIAM, gerieft Tweezers MERIAM, serrated			
3007-6	Zahnsonde UNIVERSAL, kräftige Spitzen Explorers UNIVERSAL, strong tips			
3007-9	Zahnsonde UNIVERSAL, kräftige Spitzen Explorers UNIVERSAL, strong tips			
3007-17	Zahnsonde UNIVERSAL, kräftige Spitzen Explorers UNIVERSAL, strong tips			
3007-23	Zahnsonde UNIVERSAL, kräftige Spitzen Explorers UNIVERSAL, strong tips			



SCHWERT Art.-Nr. SWORD art.-no.	Text Text	Menge Quantity	Einzelpreis Unit price	Gesamtpreis Total price
Instrumente für die konservierende Behandlung/Instruments for the conservative dentistry				
1700-510	Steri-Rahmen, für 22 Instr. Instrument tray, for 22 instr.			
2598	Steri-Rahmen PROTECTOR, für 5 Instr. Instrument tray PROTECTOR, for 5 instr.			
2598-10	Steri-Rahmen PROTECTOR, für 10 Instr. Instrument tray PROTECTOR, for 10 instr.			
3274-6	Zahnreiniger, Fig. H 6/H 7 Scaler, Fig. H 6/H 7			
3274-204	Zahnreiniger, Fig. 204 S Scaler, Fig. 204 S			
3289	Schleifstein ORIGINAL-ARKANSAS Sharpening stone ORIGINAL-ARKANSAS			
3292	Acryl-Teststäbchen, ø 7 mm Tool for sharpening test, ø 7 mm			
3297	Schleiföl Sharpening oil			
3360-1	Farbringe, P. à 50 Stck., grau Colour rings, P. of 50 pcs., grey			
3360-3	Farbringe, P. à 50 Stck., schwarz Colour rings, P. of 50 pcs., black			
3360-5	Farbringe, P. à 50 Stck., gelb Colour rings, P. of 50 pcs., yellow			
3360-7	Farbringe, P. à 50 Stck., grün Colour rings, P. of 50 pcs., green			
3360-9	Farbringe, P. à 50 Stck., rot Colour rings, P. of 50 pcs., red			
3360-11	Farbringe, P. à 50 Stck., orange Colour rings, P. of 50 pcs., orange			
3360-13	Farbringe, P. à 50 Stck., blau Colour rings, P. of 50 pcs., blue			
3360-15	Farbringe, P. à 50 Stck., braun Colour rings, P. of 50 pcs., brown			
3360-17	Farbringe, P. à 50 Stck., weiss Colour rings, P. of 50 pcs., white			
3373-5	Kürette GRACEY, Fig. 5/6 Curette GRACEY, Fig. 5/6			
3373-7	Kürette GRACEY, Fig. 7/8 Curette GRACEY, Fig. 7/8			
3373-11	Kürette GRACEY, Fig. 11/12 Curette GRACEY, Fig. 11/12			
3373-13	Kürette GRACEY, Fig. 13/14 Curette GRACEY, Fig. 13/14			
3373-204S	Zahnreiniger, Fig. 204 S Scaler, Fig. 204 S			
3374-5	Kürette GRACEY, Fig. 5/6 Curette GRACEY, Fig. 5/6			
3374-7	Kürette GRACEY, Fig. 7/8 Curette GRACEY, Fig. 7/8			
3374-11	Kürette GRACEY, Fig. 11/12 Curette GRACEY, Fig. 11/12			
3374-13	Kürette GRACEY, Fig. 13/14 Curette GRACEY, Fig. 13/14			
3377-105	Kürette GRACEY, Fig. 5/6, miniatur Curette GRACEY, Fig. 5/6, miniatur			
3377-107	Kürette GRACEY, Fig. 7/8, miniatur Curette GRACEY, Fig. 7/8, miniatur			
3377-111	Kürette GRACEY, Fig. 11/12, miniatur Curette GRACEY, Fig. 11/12, miniatur			
3377-113	Kürette GRACEY, Fig. 13/14, miniatur Curette GRACEY, Fig. 13/14, miniatur			
3379-2	Universalkürette COLUMBIA, Fig. 2L/2R Universal curette COLUMBIA, Fig. 2L/2R			
3379-4	Universalkürette COLUMBIA, Fig. 4L/4R Universal curette COLUMBIA, Fig. 4L/4R			





SCHWERT Art.-Nr. SWORD art.-no.	Text Text	Menge Quantity	Einzelpreis Unit price	Gesamtpreis Total price
Instrumente für die konservierende Behandlung/Instruments for the conservative dentistry				
3410-1	Parodontalsonde WHO Periodontal probe WHO			
3419-3-3	Parodontalsonde, Fig. CP12 Periodontal probe, Fig. CP 12			
3419-3-6	Parodontalsonde, Fig. CP11 Periodontal probe, Fig. CP 11			
3463-33	Exkavatoren Excavators			
3463-35	Exkavatoren Excavators			
3463-37	Exkavatoren Excavators			
3470-212	Exkavatoren, Fig. 212/213 Excavators, Fig. 212/213			
3470-218	Exkavatoren, Fig. 218/219 Excavators, Fig. 218/219			
3470-220	Exkavatoren, Fig. 220/221 Excavators, Fig. 220/221			
3585	Matrizenspanner, Fig. 8, 5 mm Matrix retainers, Fig. 8, 5 mm			
3587	Matrizenspanner, Fig. 8, 7 mm Matrix retainers, Fig. 8, 7 mm			
3590	Matrizenspanner TOFFLEMIRE Matrix retainers TOFFLEMIRE			
3592-1	Matrize TOFFLEMIRE Matrix TOFFLEMIRE			
3592-2	Matrize TOFFLEMIRE Matrix TOFFLEMIRE			
3592-3	Matrize TOFFLEMIRE Matrix TOFFLEMIRE			
3595	Matrize für 3585, 1 m x 5 mm Matrix for 3585, 1 m x 5 mm			
3596	Matrize für 3587, 1 m x 6 mm Matrix for 3587, 1 m x 6 mm			
3597	Matrize für 3587, 1 m x 6 mm Matrix for 3587, 1 m x 6 mm			
3902-0	Modellierinstrument Carving instrument			
3902-1	Modellierinstrument Carving instrument			
3902-2	Modellierinstrument Carving instrument			
3902-3	Modellierinstrument Carving instrument			
3904-50	Dycalstopfer Filling instrument Dycal			
4088	Flexible Spatel HEIDEMANN Flexible spatulas HEIDEMANN			
4089	Flexible Spatel HEIDEMANN Flexible spatulas HEIDEMANN			
4090	Flexible Spatel HEIDEMANN Flexible spatulas HEIDEMANN			
4122	Polierer Burnisher			
4342-2	Zementspatel Cement spatulas			
4342-3	Zementspatel Cement spatulas			
4430	Modellierinstrument HOLLENBACK Carving instrument HOLLENBACK			



SCHWERT Art.-Nr. SWORD art.-no.	Text Text	Menge Quantity	Einzelpreis Unit price	Gesamtpreis Total price
Instrumente für die Extraktion/Instruments for the extraction				
152-1	Zahnzange, für obere Schneide- u. Eckzähne Dental forceps, for upper incisors and canines			
152-7	Zahnzange, für obere Prämolaren Dental forceps, for upper premolars			
152-13	Zahnzange, für untere Eckzähne u. Premolaren Dental forceps, for lower canines and premolares			
152-17	Zahnzange, für obere Molaren, rechts Dental forceps, for upper molars, right			
152-18	Zahnzange, für obere Molaren, links Dental forceps for upper molars, left			
152-22	Zahnzange, für untere Molaren, beide Seiten Dental forceps, for lower molars, either side			
152-33	Zahnzange, für untere Schneidez. Prämolaren u. Wurzeln Dental forceps, for lower incisors, premolars and roots			
152-51	Zahnzange, für obere Wurzeln Dental forceps, for upper roots			
152-67A	Zahnzange, für obere Weisheitszähne Dental forceps, for upper wisdom teeth			
152-79	Zahnzange, für untere Weisheitszähne Dental forceps, for lower wisdom teeth			
614-2	Wurzelheber, 2 mm, gerade Elevator, 2 mm, straight			
614-3	Wurzelheber, 3 mm, gerade Elevator, 3 mm, straight			
614-4	Wurzelheber, 4 mm, gerade Elevator, 4 mm, straight			
614-12	Wurzelheber, 2 mm, gebogen Elevator, 2 mm, curved			
614-13	Wurzelheber, 3 mm, gebogen Elevator, 3 mm, curved			
614-14	Wurzelheber, 4 mm, gebogen Elevator, 4 mm, curved			
620-2	Wurzelheber BEIN, 2 mm Elevator BEIN, 2 mm			
620-3	Wurzelheber BEIN, 3 mm Elevator BEIN, 3 mm			
620-4	Wurzelheber BEIN, 4 mm Elevator BEIN, 4 mm			
810	Wurzelheber Elevator			
811	Wurzelheber Elevator			
830-1	Wurzelheber CRYER Elevator CRYER			
830-2	Wurzelheber CRYER Elevator CRYER			
925-2	Drehmeissel, 2 mm, gerade Chisel, 2 mm, straight			
925-3	Drehmeissel, 3 mm, gerade Chisel, 3 mm, straight			
925-4	Drehmeissel, 4 mm, gerade Chisel, 4 mm, straight			
926-2	Drehmeissel, 2 mm, bajonett Chisel, 2 mm, bayonet			
926-3	Drehmeissel, 3 mm, bajonett Chisel, 3 mm, bayonet			
926-4	Drehmeissel, 4 mm, bajonett Chisel, 4 mm, bayonet			
1043	Skalpellgriff, Fig. 3 Scalpel handle, Fig. 3			
1053-10	Skalpellklinge, Fig. 10, unsteril Scalpel blade, Fig. 10, non-sterile			
1053-11	Skalpellklinge, Fig. 11, unsteril Scalpel blade, Fig. 11, non-sterile			





SCHWERT Art.-Nr. SWORD art.-no.	Text Text	Menge Quantity	Einzelpreis Unit price	Gesamtpreis Total price
Instrumente für die Extraktion/Instruments for the extraction				
1053-12D	Skallpellklinge, Fig. 12D, unsteril Scalpel blade, Fig. 12D, non-sterile			
1053-15	Skallpellklinge, Fig. 15, unsteril Scalpel blade, Fig. 15, non-sterile			
1063-10	Skallpellklinge, Fig. 10, steril Scalpel blade, Fig. 10, sterile			
1063-11	Skallpellklinge, Fig. 11, steril Scalpel blade, Fig. 11, sterile			
1063-12D	Skallpellklinge, Fig. 12D, steril Scalpel blade, Fig. 12D, sterile			
1063-15	Skallpellklinge, Fig. 15, steril Scalpel blade, Fig. 15, sterile			
1110	Zahnfleissschere STANDARD Gum scissors STANDARD			
1110-400	Zahnfleissschere SUPER CUT Gum scissors SUPER CUT			
1111	Zahnfleissschere STANDARD Gum scissors STANDARD			
1111-400	Zahnfleissschere SUPER CUT Gum scissors SUPER CUT			
1143	Zahnfleissschere KELLY Gum scissors KELLY			
1143-400	Zahnfleissschere SUPER CUT Gum scissors SUPER CUT			
1147-1	Zahnfleissschere DEAN, gezahnt Gum scissors DEAN, saw edge			
1934-1	Abhalter LANGENBECK, 30 x 10 mm Retractor LANGENBECK, 30 x 10 mm			
1934-4	Abhalter LANGENBECK, 40 x 10 mm Retractor LANGENBECK, 40 x 10 mm			
2014	Nadelhalter CRILE-WOOD, Hartmetalleinsätze Needle holder CRILE-WOOD, tungsten carbide inserts			
2016-16	Nadelhalter MAYO-HEGAR Needle holder MAYO-HEGAR			
Instrumente für die Chirurgie/Instruments for the surgery				
431	Hohlmeisselzange FRIEDMANN Rongeur forceps FRIEDMANN			
1197-13	Pinzette SEMKEN, 13 cm Forceps SEMKEN, 13 cm			
1197-15	Pinzette SEMKEN, 15 cm Forceps SEMKEN, 15 cm			
1198-13	Pinzette SEMKEN, 13 cm Forceps SEMKEN, 13 cm			
1198-15	Pinzette SEMKEN, 15 cm Forceps SEMKEN, 15 cm			
1361-0	Scharfer Löffel HEMINGWAY Bone curette HEMINGWAY			
1361-1	Scharfer Löffel HEMINGWAY Bone curette HEMINGWAY			
1361-2	Scharfer Löffel HEMINGWAY Bone curette HEMINGWAY			
1407	Raspatorium MOLT Raspatory MOLT			
1408	Raspatorium FREER Raspatory FREER			
1416	Raspatorium WILLIGER Raspatory WILLIGER			
1425-1	Raspatorium Raspatory			



SCHWERT Art.-Nr. SWORD art.-no.	Text Text	Menge Quantity	Einzelpreis Unit price	Gesamtpreis Total price
Instrumente für die Chirurgie/Instruments for the surgery				
1425-2	Raspatorium Raspatory			
1510-1	Tamponstopfer LUNIATSCHEK Tampon applicator LUNIATSCHEK			
Instrumente für die Prothetik/Instruments for the prosthodontia				
1626	Hammer, 200 g, bleigefüllt Mallet, 200 g, lead filled			
4444	Modellierinstrument LE CRON Carving instrument LE CRON			
4446	Modellierinstrument HYLIN-LE CRON Carving instrument HYLIN-LE CRON			
4510	Wachsmesser FAHNENSTOCK Wax knives FAHNENSTOCK			
4512	Wachsmesser FAHNENSTOCK Wax knives FAHNENSTOCK			
4542	Wachsmesser GRITMANN Wax knives GRITMANN			
4558	Gippschneidezange Plaster cutting pliers			
4560	Anmischspatel, sehr flexibel Spatula, very flexible			
4570	Anmischspatel LICHTENSTEIN Spatula LICHTENSTEIN			
4571	Anmischspatel Spatula			
4825	Kronenschere BEEBEE, spitz, gebogen Crown scissors BEEBEE, sharp, curved			
4880-3	Retraktionsfadenstopfer UNIVERSAL, 45°, gezahnt Gingival cord packer UNIVERSAL, 45°, saw edge			
4880-4	Retraktionsfadenstopfer, 45°, gezahnt Gingival cord packer, 45°, saw edge			
4890	Artikulationspapierpinzette MILLER Forceps for articulating paper MILLER			
4894	Zehntelmass IWANSON Decimal caliper IWANSON			
4920	Kronenabnehmer TREYMANN Crown remover TREYMANN			
4924-1	Ansatz für Kronenabnehmer Art.-Nr. 4925 Tips for crown remover art.-no. 4925			
4924-2	Ansatz für Kronenabnehmer Art.-Nr. 4925 Tips for crown remover art.-no. 4925			
4925	Kronenabnehmer MORELL Crown remover MORELL			
4927	Kronenabnehmer UNIVERSAL Crown remover UNIVERSAL			
4940-17	Kronenabnehmezange Crown trial forceps			
4940-22	Kronenabnehmezange Crown trial forceps			
4940-100	1 Paar Kunststoffbacken für Art.-Nr. 4940-17 u. 4940-22 1 pair of inserts for art.-no. 4940-17 u. 4940-22			
4947-5	Teleskopkronenzange, diamantierte Spitze, auswechselbar Pliers for telescope crowns, diamonded tips, replaceable			
4947-6	1 Paar Ersatzspitzen für Art.-Nr. 4947-5 1 pair of replacement tips for art.-no. 4947-5			
5024	Flachzange, gerieft Flat nose pliers, serrated			
5133	Drahtbiegezange ADERER, Fig. 200 Wire bending pliers ADERER, Fig. 200			





SCHWERT Art.-Nr. SWORD art.-no.	Text Text	Menge Quantity	Einzelpreis Unit price	Gesamtpreis Total price
Instrumente für die Prothetik/Instruments for the prosthodontia				
5309	Ligaturzange WEINGART Ligature pliers WEINGART			
5600	Kramponzange Pin bending pliers			
Abformlöffel/Impression trays				
4972-110	Abformlöffel ANATOMIC-EHRICKE, Oberkiefer, SUP B0 Impression tray ANATOMIC-EHRICKE, upper jaw, SUP B0			
4972-111	Abformlöffel ANATOMIC-EHRICKE, Oberkiefer, SUP B1 Impression tray ANATOMIC-EHRICKE, upper jaw, SUP B1			
4972-112	Abformlöffel ANATOMIC-EHRICKE, Oberkiefer, SUP B2 Impression tray ANATOMIC-EHRICKE, upper jaw, SUP B2			
4972-113	Abformlöffel ANATOMIC-EHRICKE, Oberkiefer, SUP B3 Impression tray ANATOMIC-EHRICKE, upper jaw, SUP B3			
4972-114	Abformlöffel ANATOMIC-EHRICKE, Oberkiefer, SUP B4 Impression tray ANATOMIC-EHRICKE, upper jaw, SUP B4			
4972-121	Abformlöffel ANATOMIC-EHRICKE, Oberkiefer, SUP P1 Impression tray ANATOMIC-EHRICKE, upper jaw, SUP P1			
4972-122	Abformlöffel ANATOMIC-EHRICKE, Oberkiefer, SUP P2 Impression tray ANATOMIC-EHRICKE, upper jaw, SUP P2			
4972-123	Abformlöffel ANATOMIC-EHRICKE, Oberkiefer, SUP P3 Impression tray ANATOMIC-EHRICKE, upper jaw, SUP P3			
4972-131	Abformlöffel ANATOMIC-EHRICKE, Oberkiefer, SUP U1 Impression tray ANATOMIC-EHRICKE, upper jaw, SUP U1			
4972-132	Abformlöffel ANATOMIC-EHRICKE, Oberkiefer, SUP U2 Impression tray ANATOMIC-EHRICKE, upper jaw, SUP U2			
4972-133	Abformlöffel ANATOMIC-EHRICKE, Oberkiefer, SUP U3 Impression tray ANATOMIC-EHRICKE, upper jaw, SUP U3			
4972-210	Abformlöffel ANATOMIC-EHRICKE, Unterkiefer, INF B0 Impression tray ANATOMIC-EHRICKE, lower jaw, INF B0			
4972-211	Abformlöffel ANATOMIC-EHRICKE, Unterkiefer, INF B1 Impression tray ANATOMIC-EHRICKE, lower jaw, INF B1			
4972-212	Abformlöffel ANATOMIC-EHRICKE, Unterkiefer, INF B2 Impression tray ANATOMIC-EHRICKE, lower jaw, INF B2			
4972-213	Abformlöffel ANATOMIC-EHRICKE, Unterkiefer, INF B3 Impression tray ANATOMIC-EHRICKE, lower jaw, INF B3			
4972-214	Abformlöffel ANATOMIC-EHRICKE, Unterkiefer, INF B4 Impression tray ANATOMIC-EHRICKE, lower jaw, INF B4			
4972-221	Abformlöffel ANATOMIC-EHRICKE, Unterkiefer, INF P1 Impression tray ANATOMIC-EHRICKE, lower jaw, INF P1			
4972-222	Abformlöffel ANATOMIC-EHRICKE, Unterkiefer, INF P2 Impression tray ANATOMIC-EHRICKE, lower jaw, INF P2			
4972-223	Abformlöffel ANATOMIC-EHRICKE, Unterkiefer, INF P3 Impression tray ANATOMIC-EHRICKE, lower jaw, INF P3			
4975-111	Abformlöffel ANATOMIC-PERIGRIP, Oberkiefer, SUP1 Impression tray ANATOMIC PERIGRIP, upper jaw, SUP1			
4975-112	Abformlöffel ANATOMIC-PERIGRIP, Oberkiefer, SUP2 Impression tray ANATOMIC PERIGRIP, upper jaw, SUP2			
4975-113	Abformlöffel ANATOMIC-PERIGRIP, Oberkiefer, SUP3 Impression tray ANATOMIC PERIGRIP, upper jaw, SUP3			
4975-114	Abformlöffel ANATOMIC-PERIGRIP, Oberkiefer, SUP4 Impression tray ANATOMIC PERIGRIP, upper jaw, SUP4			
4975-115	Abformlöffel ANATOMIC-PERIGRIP, Oberkiefer, SUP5 Impression tray ANATOMIC PERIGRIP, upper jaw, SUP5			
4975-211	Abformlöffel ANATOMIC-PERIGRIP, Unterkiefer, INF1 Impression tray ANATOMIC PERIGRIP, lower jaw, INF1			
4975-212	Abformlöffel ANATOMIC-PERIGRIP, Unterkiefer, INF2 Impression tray ANATOMIC PERIGRIP, lower jaw, INF2			
4975-213	Abformlöffel ANATOMIC-PERIGRIP, Unterkiefer, INF3 Impression tray ANATOMIC PERIGRIP, lower jaw, INF3			



SCHWERT Art.-Nr. SWORD art.-no.	Text Text	Menge Quantity	Einzelpreis Unit price	Gesamtpreis Total price
Abformlöffel/Impression trays				
4975-214	Abformlöffel ANATOMIC-PERIGRIP, Unterkiefer, INF4 Impression tray ANATOMIC PERIGRIP, lower jaw, INF4			
4975-215	Abformlöffel ANATOMIC-PERIGRIP, Unterkiefer, INF5 Impression tray ANATOMIC PERIGRIP, lower jaw, INF5			
4978-1	Abformlöffel ANATOMIC, L1 Impression tray ANATOMIC, L1			
4978-2	Abformlöffel ANATOMIC, L2 Impression tray ANATOMIC, L2			
4978-3	Abformlöffel ANATOMIC, L3 Impression tray ANATOMIC, L3			
4979-1	Abformlöffel ANATOMIC, R1 Impression tray ANATOMIC, R1			
4979-2	Abformlöffel ANATOMIC, R2 Impression tray ANATOMIC, R2			
4979-3	Abformlöffel ANATOMIC, R3 Impression tray ANATOMIC, R3			
4983	Abformlöffel STOLLEY, mit Schraube Impression tray STOLLEY, with screw			

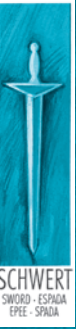

INDEX

CAT.-NO.	PAGE	CAT.-NO.	PAGE	CAT.-NO.	PAGE	CAT.-NO.	PAGE
152-1	12	1361-0	19	3377-105	11	4920	23
152-7	12	1361-1	19	3377-107	11	4924-1	23
152-13	13	1361-2	19	3377-111	11	4924-2	23
152-17	12	1407	18	3377-113	11	4925	23
152-18	12	1408	18	3379-2	8	4927	23
152-22	13	1416	18	3379-4	8	4940-17	22
152-33	13	1425-1	18	3410-1	8	4940-22	22
152-51	13	1425-2	18	3419-3-3	8	4940-100	22
152-67A	12	1510-1	19	3419-3-6	8	4947-5	20
152-79	13	1626	22	3462-33	4	4947-6	20
431	19	1700-510	11	3462-35	4	4972-110	27
614-2	14	1934-1	17	3462-37	4	4972-111	27
614-3	14	1934-4	17	3470-212	4	4972-112	27
614-4	14	2014	17	3470-218	4	4972-113	27
614-12	14	2016-16	17	3470-220	4	4972-114	27
614-13	14	2598	9	3585	7	4972-121	27
614-14	14	2598-10	11	3587	7	4972-122	27
620-2	15	2770	3	3590	7	4972-123	27
620-3	15	2784	2	3592-1	7	4972-131	27
620-4	15	2787	2	3592-2	7	4972-132	27
810	15	2800-4	2	3592-3	7	4972-133	27
811	15	2885	2	3595	7	4972-210	27
830-1	15	2943	2	3596	7	4972-211	27
830-2	15	3007-6	3	3597	7	4972-212	27
925-2	14	3007-9	3	3902-0	5	4972-213	27
925-3	14	3007-17	3	3902-1	5	4972-214	27
925-4	14	3007-23	3	3902-2	5	4972-221	27
926-2	14	3274-6	6	3902-3	5	4972-222	27
926-3	14	3274-204	6	3904-50	6	4972-223	27
926-4	14	3289	7	4088	5	4975-111	26
1043	16	3292	7	4089	5	4975-112	26
1053-10	16	3297	7	4090	5	4975-113	26
1053-11	16	3360-1	10	4122	6	4975-114	26
1053-12D	16	3360-3	10	4342-2	4	4975-115	26
1053-15	16	3360-5	10	4342-3	4	4975-211	26
1063-10	16	3360-7	10	4430	5	4975-212	26
1063-11	16	3360-9	10	4444	25	4975-213	26
1063-12D	16	3360-11	10	4446	25	4975-214	26
1063-15	16	3360-13	10	4510	25	4975-215	26
1110	16	3360-15	10	4512	25	4978-1	26
1110-400	16	3360-17	10	4542	25	4978-2	26
1111	16	3373-5	9	4558	24	4978-3	26
1111-400	16	3373-7	9	4560	21	4979-1	26
1143	16	3373-11	9	4570	21	4979-2	26
1143-400	16	3373-13	9	4571	21	4979-3	26
1147-1	16	3373-204S	9	4825	24	4983	26
1197-13	18	3374-5	10	4880-3	20	5024	24
1197-15	18	3374-7	10	4880-4	20	5133	24
1198-13	18	3374-11	10	4890	20	5309	24
1198-15	18	3374-13	10	4894	24	5600	24

SCHWERT – SYNONYM FÜR QUALITÄT & VERTRAUEN

Made in Germany

SWORD – SYNONYM FOR QUALITY & TRUST

A. Schweickhardt GmbH & Co. KG

**Hersteller zahnärztlicher und
chirurgischer Instrumente**

Postfach 69
D-78501 Tuttlingen, Deutschland
Telefon +49 (74 61) 92 97-0
Telefax +49 (74 61) 92 97-19

contact@schwert.com
www.schwert.com

A. Schweickhardt GmbH & Co. KG

**Manufacturer of dental and
surgical instruments**

P.O. Box 69
D-78501 Tuttlingen, Germany
Phone +49 (74 61) 92 97-0
Fax +49 (74 61) 92 97-19

contact@schwert.com
www.schwert.com

